

EN

User manual

Washer Dryer

# USER MANUAL

ZWT 71201 WA

**ZANUSSI**

## Contents

---

Safety information _____	2	Use - Drying _____	16
Safety instructions _____	3	Care and cleaning _____	18
Product description _____	5	What to do if... _____	20
Control panel _____	6	Technical data _____	23
Washing programmes _____	9	Consumption values _____	24
Drying Programmes _____	11	Installation _____	24
Helpful hints and tips _____	11	Building in _____	28
First use _____	13	Electrical connection _____	31
Personalisation _____	13	Environment concerns _____	31
Daily Use _____	14		

Subject to change without notice.

## Safety information

---

Before the installation and use of the appliance, carefully read the supplied instructions. The manufacturer is not responsible if an incorrect installation and use causes injuries and damages. Always keep the instructions with the appliance for future reference.

### Children and vulnerable people safety

**⚠ Warning!** Risk of suffocation, injury or permanent disability.

- Do not let persons, children included, with reduced physical sensory, reduced mental functions or lack of experience and knowledge use the appliance. They must have supervision or instruction for the operation of the appliance by a person who is responsible for their safety.
- Do not let children play with the appliance.
- Keep all packaging away from children.
- Keep all detergents away from children.
- Keep children and pets away from the appliance door when it is open.
- If the appliance has a child safety device, we recommend you activate it.

### General Safety

- Before maintenance, deactivate the appliance and disconnect the mains plug from the mains socket.

- Do not change the specification of this appliance.
- Obey the maximum load volume of 8 kg (refer to the “Programme chart” chapter).
- If the supply cord is damaged, it must be replaced by the manufacturer, its service agent or similarly qualified persons in order to avoid a hazard.
- The operating water pressure (minimum and maximum) must be between 0,5 bar (0,05 MPa) and 8 bar (0,8 MPa)
- The ventilation openings in the base (if applicable) must not be obstructed by a carpet.
- The appliance is to be connected to the water mains using the new supplied hose-sets. Old hose sets must not be reused.



## Safety instructions

### Installation

- Remove all the packaging and the transit bolts.
- Keep the transit bolts. When you move the appliance again you must block the drum.
- Do not install or use a damaged appliance.
- Do not install or use the appliance where the temperature is less than 0 °C or where it is exposed to the weather.
- Obey the installation instruction supplied with the appliance.
- Make sure that the floor where you install the appliance is flat, stable, heat resistant and clean.
- Do not install the appliance where the appliance door can not be fully opened.
- Always be careful when you move the appliance because it is heavy. Always wear safety gloves.
- Make sure that there is air circulation between the appliance and the floor.
- Adjust the feet to have the necessary space between the appliance and the carpet.

### Electrical connection



### Warning! Risk of fire and electrical shock.

- The appliance must be earthed.
- Make sure that the electrical information on the rating plate agrees with the power supply. If not, contact an electrician.
- Always use a correctly installed shockproof socket.
- Do not use multi-plug adapters and extension cables.
- Make sure not to cause damage to the mains plug and to the mains cable. Should the appliance power supply cable need to be replaced, this must be carried out by our Service Centre.
- Connect the mains plug to the mains socket only at the end of the installation. Make sure that there is access to the mains plug after the installation.
- Do not pull the mains cable to disconnect the appliance. Always pull the mains plug.
- Do not touch the mains cable or the mains plug with wet hands.
- Only for UK and Ireland. The appliance has a 13 amp mains plug. If it is necessary to

change the fuse in the mains plug, use a 13 amp ASTA (BS 1362) fuse.

This appliance complies with the E.E.C. Directives.

### Water connection

- Make sure not to cause damage to the water hoses.
- The appliance is to be connected to the water mains using the new supplied hose-sets. Old hose sets must not be reused.
- Before you connect the appliance to new pipes or pipes not used for a long time, let the water flow until it is clean.
- The first time you use the appliance, make sure that there is no leakage.

### Use

 **Warning!** Risk of injury, electrical shock, fire, burns or damage to the appliance.

- Use this appliance in a household only.
- Do not change the specification of this appliance.
- Do not put flammable products or items that are wet with flammable products in, near or on the appliance.
- Do not touch the glass of the door while a programme operates. The glass can be hot.
- Make sure that you remove all metal objects from the laundry.
- The final part of the drying cycle occurs without heat (cool down cycle) to ensure that the items will not be damaged.

If you stop the appliance before the end of the drying cycle, immediately remove and spread out all items, so that the heat can dissipate.

- If you use detergent, fabric softener or similar products, obey the instructions on the packaging.
- Wipe away lint that has accumulated around the appliance.
- Do not dry the damaged items which contain padding or fillings .

- Do not dry items such as foam rubber (latex foam), shower caps, waterproof textiles and rubber backed articles.
- Before drying items that have been in contact with substances such as cooking oil, acetone, alcohol , petrol, kerosene, spot removers, turpentine, waxes and wax removers, wash them in hot water with an extra amount of detergent.
- Do not dry items if industrial chemicals have been used for cleaning.
- Make sure that no gas lighters or matches have been left in the pockets of the clothing.
- Only dry fabrics which are applicable to dry in the tumble dryer. Follow the instructions on the fabric label.
- Do not dry not washed items in the appliance.
- If you have washed your laundry with a stain remover start an extra rinse cycle before you start the appliance.
- Plastic items are not heat resistant.
  - If you use a detergent ball, remove it before you set the drying programme.
  - Do not use a detergent ball when you set a non-stop programme.

 **Warning!** Risk of injury or damage to the appliance.

- Do not sit or stand on the open door.
- Obey the maximum load volume.
- Do not dry dripping wet clothes in the appliance.

### Care and Cleaning

 **Warning!** Risk of injury or damage to the appliance.

- Do not use water spray and steam to clean the appliance.
- Clean the appliance with a moist soft cloth. Only use neutral detergents. Do not use abrasive products, abrasive cleaning pads, solvents or metal objects.

### Disposal

 **Warning!** Risk of injury or suffocation.

- Disconnect the appliance from the mains supply.

- Cut off the mains cable and discard it.
- Remove the door catch to prevent children and pets to get closed in the appliance.

## Product description

- 1 Detergent dispenser drawer
- 2 Control panel
- 3 Door opening handle
- 4 Rating plate
- 5 Drain pump
- 6 Adjustable feet

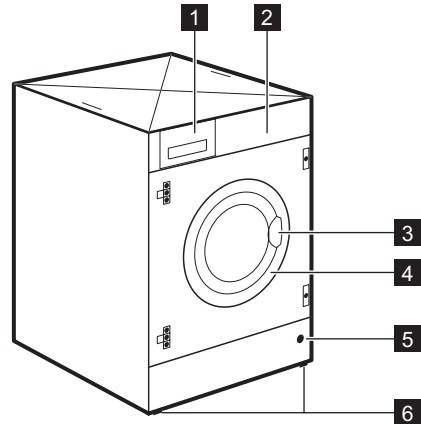

### Child safety

Make sure that children or pets do not climb into the drum. To prevent children and pets becoming trapped inside the drum this machine incorporates a special feature.

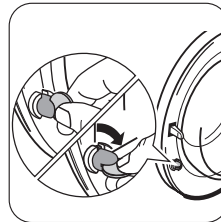

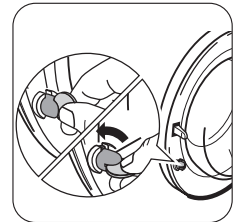

**To activate** this device, rotate the button (without pressing it) inside the door clockwise until the groove is horizontal. If necessary use a coin.



**To disable** this device and restore the possibility of closing the door, rotate the button anti-clockwise until the groove is vertical.

## Detergent dispenser drawer

 Compartment for detergent used for pre-wash and soak phase or for stain remover used during the stain action phase (if available). The prewash and soak detergent is added at the beginning of the wash programme. The stain remover is added during the stain action phase.

 Compartment for powder or liquid detergent used for main wash. If using liquid detergent pour it **just before** starting the programme.

 Compartment for liquid additives (fabric softener, starch).

Follow the product manufacturer's recommendations on quantities to use and do not exceed the «MAX» mark in the detergent dispenser drawer. Any fabric softener or starching additives must be poured into the compartment before starting the wash programme.

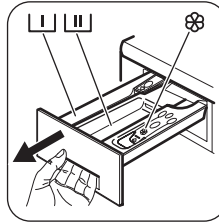

## Control panel

 On the following page there is a picture of the control panel. It shows the programme selector dial as well as the buttons, pilot lights and the display. These are presented by relevant numbers on the following pages.

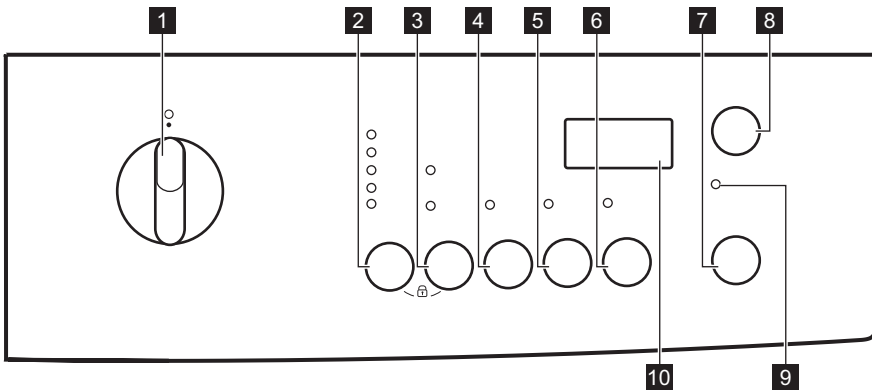

**1** Programme selector dial

**2** SPIN reduction button

**3** OPTION button

**4** EXTRA RINSE button

**5** DRYING TIME button

**6** EASY IRON button

**7** START/PAUSE button

**8** DELAY START button

**9** DOOR LOCKED pilot light

**10** Display

## **1-8 Programme selector dial, spin speed button, drying level and time, and available options**

### **Programme Selector Dial**

It allows you to switch the appliance on/off and/or to select a programme.

### **Spin**

By pressing this button you can change the spin speed of the set programme or select the available option(s).

### **Rinse hold**

By selecting this function the water of the last rinse is not emptied out to prevent the fabrics from creasing. Before opening the door it will be necessary to empty out the water. To empty out the water, please read the paragraph «At the end of the programme».

### **Eco**

Only for cottons and synthetic items lightly or normally soiled at a temperature of 40°C or higher. The washing time will be prolonged and the washing temperature will be reduced. You can use this option if you want to wash normally soiled laundry and at the same time save energy.

### **Quick Wash**

A very short cycle for lightly soiled items or for laundry which needs only freshening up. We recommend you to reduce the fabrics loading.

### **Extra Rinse**

This appliance is designed to save energy. If it necessary to rinse the laundry using an extra quantity of water (extra rinse), select this option. Some additional rinses will be performed. This option is recommended for people who are allergic to detergents, and in areas where the water is very soft.

### **Drying Time**

If you wish to carry out a timed drying programme, press this button until the drying time

you want appears on the display according to the fabrics (cottons or synthetics) you have to dry. For Cottons you can select a drying time from 10 minutes to 250 minutes (4.10). For Synthetics you can select a drying time from 10 minutes to 130 minutes (2.10). Every time you press this button the drying time increases by 5 mins.

### **Easy Iron**

By selecting this option the laundry is gently washed and spun to avoid any creasing. In this way ironing is easier. Furthermore the machine will perform some additional rinses in some programmes. On cotton programmes the maximum spin speed is reduced automatically.

### **Start Pause**

This button allows you to start or to interrupt the selected programme.

### **Delay Start**

The programme can be delayed from 30 min - 60 min - 90 min, 2 hours and then by 1 hour up to a maximum of 20 hours by means of this button.

### **Door light**

The pilot light **9** illuminates when the programme starts and indicates if the door can be opened:

- light on: the door cannot be opened. The machine is working or has stopped with water left in the tub.
- light off: the door can be opened. The programme is finished or the water has been emptied out.
- light blinking: the door is opening in a few minutes.

## 10 Display

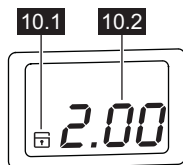













The display shows the following information:

<b>10.1</b>	<b>Child safety lock</b> This device permits you to leave the appliance unattended during it's functioning.
<b>10.2</b>	<ul style="list-style-type: none"><li>▪ <b>Duration of the selected programme</b> After selecting a programme, the duration is displayed in hours and minutes (for example <i>2.05</i>). The duration is calculated automatically on the basis of the maximum recommended load for each type of fabric. After the programme has started, the time remaining is updated every minute.</li><li>▪ <b>Selected drying time</b> After selecting a drying programme the drying time is shown in minutes or hours and minutes. After the programme has started, the time remaining is updated every minute.</li><li>▪ <b>Delayed start</b> The Selected delay set by pressing the relevant button appears on the display for a few seconds, then the duration of the selected programme is displayed again. The delay time value decreases by one unit every hour and then, when 1 hour remains, every minute.</li><li>▪ <b>Alarm codes</b> In the event of operating problems, some alarm codes can be displayed, for example <i>E20</i> (see paragraph «What to do if...»).</li><li>▪ <b>Incorrect option selection</b> If an option which is not compatible with the set wash programme is selected, the message <b>Err</b> is displayed at the bottom of the display for a few seconds and the integrated red light of button <b>7</b> start flashing.</li><li>▪ <b>End of programme</b> When the programme has finished the flashing zero ( <i>0</i> ) is displayed, the pilot light <b>9</b> and the pilot light of button <b>7</b> go out and the door can be opened.</li></ul>



# Washing programmes

Programme Maximum and Minimum Temperature Cycle Description Maximum Spin Speed Maximum Fabrics Load Type of Laundry		Options	Detergent Compartment
Cottons	<b>1-2-3-4-5</b> 90°- Cold Main wash - Rinses Long spin at maximum speed Max. load 7 kg - Reduced load 3 kg <sup>1)</sup> <b>For white and coloured cotton</b> (normally soiled items).	SPIN RINSE HOLD ECO <sup>2)</sup> SUPER QUICK EXTRA RINSE EASY IRON	 
	<b>6-7-8</b> 90°-40° Prewash - Main wash - Rinses Long spin at maximum speed Max. load 7 kg - Reduced load 3 kg <sup>1)</sup> <b>For white or coloured cottons</b> with prewash phase (heavily soiled items).	SPIN RINSE HOLD ECO SUPER QUICK EXTRA RINSE EASY IRON	 <sup>3)</sup>  
Synthetics	<b>9-10-11-12</b> 60°- Cold Main wash - Rinses Short spin at 900 rpm Max. load 3 kg - Reduced load 1,5 kg <sup>1)</sup> <b>Synthetic or mixed fabrics:</b> underwear, coloured garments, non-shrink shirts, blouses.	SPIN RINSE HOLD ECO <sup>2)</sup> SUPER QUICK EXTRA RINSE EASY IRON	 
	<b>13-14-15</b> 40°- Cold Main wash - Rinses Short spin at 700 rpm Max. load kg 3 - Reduced. load kg 1,5 <sup>1)</sup> <b>Delicate fabrics:</b> acrylics, viscose, polyester.	RINSE HOLD SUPER QUICK EXTRA RINSE	 
Delicates	<b>16-Jeans</b> 40° Main wash - Rinses Long spin at 3 rpm Max. load 3 kg With this programme it is possible to wash items like pants, shirts or jackets in denim and also jersey realized with hi-tech materials. (The Extra Rinse option will be activated automatically).	SPIN RINSE HOLD EASY IRON	 

<b>Programme</b> <b>Maximum and Minimum Temperature</b> <b>Cycle Description</b> <b>Maximum Spin Speed</b> <b>Maximum Fabrics Load</b> <b>Type of Laundry</b>		Options	Detergent Compartment
	<b>17-18-19 Handwash</b> 40°- Cold Main wash - Rinses Short spin at 900 rpm Max. load 2 kg Special programme for delicate fabrics with «hand washing» care symbol and machine washable wollens.	SPIN RINSE HOLD	
Dry	<b>20-Cottons</b> Drying programme for cotton items		
	<b>21-Synthetics</b> Drying programme for synthetic items		
	<b>22-Rinses</b> Rinses Long spin at maximum speed Max. load 7 kg With this programme it is possible to rinse and spin cotton garments which have been washed by hand. The machine performs 3 rinses, followed by a final long spin. The spin speed can be reduced.	SPIN RINSE HOLD EXTRA RINSE EASY IRON	
Extra	<b>23-Drain</b> Draining of water Max. load 7 kg For emptying out the water of the last rinse in programmes with the Rinse Hold option selected.		
	<b>24-Spin</b> Drain and long spin Long spin at maximum speed Max. load 7 kg Separate spin for hand washed garments and after programmes with the Rinse Hold option selected. You can choose the spin speed by pressing the relevant button to adapt it to the fabrics to be spun.	SPIN	

① For cancelling the programme which is running or to switch the machine off .

- 1) If you select the Super Quick option by pressing button **3**, we recommend that you reduce the maximum load as indicated. Full loading is possible however with somewhat reduced cleaning results.
- 2) This option can be selected at the temperature of 40°C or higher only.
- 3) If using liquid detergents, a programme without PREWASH must be selected.

# Drying Programmes

Degree of Drying	Type of Fabric	Drying Load	Spin Speed	Suggested drying time in Minutes
<b>Ideal for towelling materials</b>	<b>Cotton and linen</b> (bathrobes, bath towels, etc)	4 kg 3 kg 1.5 kg	<b>1200</b>	180 - 200 120 - 130 85 - 95
<b>Suitable for items to put away without ironing<sup>1)</sup></b>	<b>Cotton and linen</b> (bathrobes, bath towels, etc)	4 kg 3 kg 1.5 kg	<b>1200</b>	170 - 190 110 - 120 75 - 85
<b>Suitable for items to put away without ironing</b>	<b>Synthetics and mixed fabrics</b>	2 kg 1 kg	<b>900</b>	100 - 110 60 - 70
<b>Suitable for ironing</b>	<b>Cotton and linen</b> (sheets, tablecloths, shirts, etc.)	4 kg 3 kg 1.5 kg	<b>1200</b>	140 - 160 90 - 100 60 - 70

1) In compliance with EC directive EN 50229 the cotton reference programme for the data entered in the Energy Label must be tested dividing the maximum washing load by two equal parts and drying with DRYING TIME each of them.

## Helpful hints and tips

### Sorting out the laundry

Follow the wash code symbols on each garment label and the manufacturer's washing instructions. Sort the laundry as follows: whites, coloureds, synthetics, delicates, woollens.

### Before loading the laundry

Never wash whites and coloureds together. Whites may lose their «whiteness» in the wash. New coloured items may run in the first wash; they should therefore be washed separately the first time.

Button up pillowcases, close zip fasteners, hooks and poppers. Tie any belts or long tapes. Remove persistent stains before washing. Rub particularly soiled areas with a special detergent or detergent paste.

Treat curtains with special care. Remove hooks or tie them up in a bag or net.

### Removing stains

Stubborn stains may not be removed by just water and detergent. It is therefore advisable to treat them prior to washing.

**Blood:** treat fresh stains with cold water. For dried stains, soak overnight in water with a special detergent then rub in the soap and water.

**Oil based paint:** moisten with benzine stain remover, lay the garment on a soft cloth and dab the stain; treat several times.

**Dried grease stains:** moisten with turpentine, lay the garment on a soft surface and dab the stain with the fingertips and a cotton cloth.

**Rust:** oxalic acid dissolved in hot water or a rust removing product used cold. Be careful with rust stains which are not recent since the cellulose structure will already have been damaged and the fabric tends to hole.

**Mould stains:** treat with bleach, rinse well (whites and fast coloureds only).

**Grass:** soap lightly and treat with bleach (whites and fast coloureds only).

**Ball point pen and glue:** moisten with acetone<sup>1)</sup>, lay the garment on a soft cloth and dab the stain.

**Lipstick:** moisten with acetone as above, then treat stains with methylated spirits. Treat any residual marks with bleach.

1) do not use acetone on artificial silk

**Red wine:** soak in water and detergent, rinse and treat with acetic or citric acid, then rinse.

Treat any residual marks with bleach.

**Ink:** depending on the type of ink, moisten the fabric first with acetone<sup>1)</sup>, then with acetic acid; treat any residual marks on white fabrics with bleach and then rinse thoroughly.

**Tar stains:** first treat with stain remover, methylated spirits or benzene, then rub with detergent paste.

### Detergents and additives

Good washing results also depend on the choice of detergent and use of the correct quantities to avoid waste and protect the environment.

Although biodegradable, detergents contain substances which, in large quantities, can upset the delicate balance of nature.

The choice of detergent will depend on the type of fabric (delicates, woollens, cottons, etc.), the colour, washing temperature and degree of soiling.

All commonly available washing machine detergents may be used in this appliance:

- powder detergents for all types of fabric
- powder detergents for delicate fabrics (60°C max) and woollens
- liquid detergents, preferably for low temperature wash programmes (60°C max) for all types of fabric, or special for woollens only.

The detergent and any additives must be placed in the appropriate compartments of the

## Drying Hints

### Preparing the drying cycle

As a dryer, the appliance works on the condensation principle.

**Therefore, the water tap must be open and the drain hose must drain water into a sink or into the drain pipe, even during the drying cycle.**

#### Attention!

Before starting the drying programme, reduce the loads of washed laundry, in order to obtain good performances.

dispenser drawer before starting the wash programme.

If using liquid detergents, a programme **without** prewash must be selected.

Your appliance incorporates a recirculation system which allows an optimal use of the concentrated detergent.

Follow the product manufacturer's recommendations on quantities to use and do **not exceed the «MAX» mark in the detergent dispenser drawer.**

### Quantity of detergent to be used

The type and quantity of detergent will depend on the type of fabric, load size, degree of soiling and hardness of the water used.

Follow the product manufacturers' instructions on quantities to use.

Use less detergent if:

- you are washing a small load
- the laundry is lightly soiled
- large amounts of foam form during washing.

### Degrees of water hardness

Water hardness is classified in so-called "degrees" of hardness. Information on hardness of the water in your area can be obtained from the relevant water supply company, or from your local authority. If the water hardness degree is medium or high we suggest you to add a water softener following always the manufacturer's instructions. When the degree of hardness is soft, readjust the quantity of the detergent.

### Laundry not suitable for drying

- Particularly delicate items such as synthetic curtains, woollen and silk, garments with metal inserts, nylon stockings, bulky garments such as anoraks, bed covers, quilts, sleeping bags and duvets must not be machine dried.
- Avoid drying dark clothes with light coloured fluffy items such as towels as these can attract the fluff.
- Remove the laundry when the appliance has finished drying.

- To avoid a static charge when drying is completed, use either a fabric softener when you are washing the laundry or a fabric conditioner specifically for tumble dryers.
- Garments padded with foam-rubber or materials similar to foam-rubber must not be machine dried; they represent a fire hazard.
- Also, fabrics containing residue of setting lotions or hair sprays, nail solvents or similar solutions must not be machine dried in order to avoid the formation of harmful vapours.

The detergent and any additives must be placed in the appropriate compartments of the dispenser drawer before starting the wash programme.





If using liquid detergents, a programme **without** prewash must be selected.

Your appliance incorporates a re-circulation system which allows an optimal use of the concentrated detergent.

Follow the product manufacturer's recommendations on quantities to use and do **not exceed the «MAX» mark in the detergent dispenser drawer.**

### Garment labels

For drying, follow the indications given on the manufacturer's labels:

-  = May be tumble dried
-  = Drying at high temperature
-  = Drying at reduced temperature
-  = Do not tumble dry.

### Drying cycle duration

The drying time may vary depending on:

- speed of the final spin
- dryness degree required (iron dry, store dry)
- type of laundry
- weight of the load size .

The average drying time for a timed drying are indicated in the «Drying programmes» chapter. The experience will help you to dry your laundry in a more suitable way, according to the different fabrics. Take note of the duration drying time of the already performed cycles.

### Additional drying

If the laundry is still damp at the end of the drying programme, select a short drying cycle again.

 **Warning! Do not over dry the laundry in order to avoid creasing of fabrics or garment's shrinking.**

## First use

-  ▪ Ensure that the electrical and water connections comply with the installation instructions.
- Remove the polystyrene block and any material from the drum.
- Before the first wash, run a cotton cycle at the highest temperature without any

laundry in the machine, to remove any manufacturing residue from the drum and tub. Pour 1/2 a measure of detergent into the main wash compartment and start the machine.

## Personalisation

### Acoustic signals

The machine is provided with an acoustic device, which sounds in the following cases:

- at the end of the cycle
- if there is a fault.

By pressing the **4** and **5** buttons simultaneously for about **6 seconds**, the acoustic signal is de-

activated (except if there is a fault). By pressing these 2 buttons again, the acoustic signal is re-activated.

### Child safety lock

This device permits you to leave the appliance unattended so you do not need to worry that children might be injured by or cause damage

to the appliance. This function remains enabled also when the washing machine is not working. There are two different ways to set this option:

1. Before pressing button **7**: it will be impossible to start the machine.
2. After pressing button **7**: it will be impossible to change any other programme or option.

## Daily Use

### Load the laundry

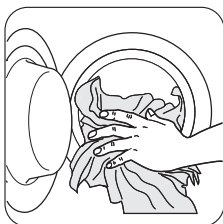

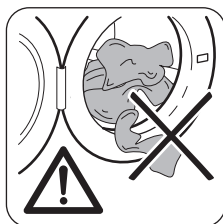

Open the door by carefully pulling the door handle outwards. Place the laundry in the drum, one item at a time, shaking them out as much as possible. Close the door.



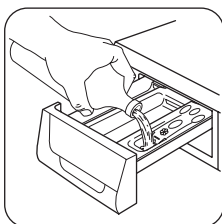
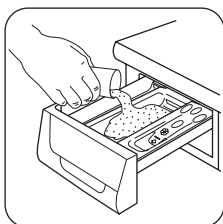

Make sure that no laundry stays between the seal and the door. There is a risk of water leakage or damage to the laundry.

### Measure out the detergent and the fabric softener



To enable or disable this option press simultaneously for about 6 seconds buttons **2** and **3** until on the display, the icon  appears or disappears.

Pull out the dispenser drawer until it stops. Measure out the amount of detergent required, pour it into the main wash compartment  or in the appropriate compartment if the selected programme/option it requires (see more details in "Detergent dispenser drawer").

If required, pour fabric softener into the compartment marked  (the amount used must not exceed the «MAX» mark in the drawer). Close the drawer gently.

### Select the required programme by means of the programme selector dial (1)

Turn the programme selector dial to the required programme.

The green pilot light of button **7** starts to flash. The selector dial can be turned either clockwise or anticlockwise.

Turn the selector dial to position  to reset the programme/to switch the machine OFF.

**At the end of the programme the selector dial must be turned to position , to switch the machine off.**

**Important!** If you turn the programme selector dial to another programme when the machine is working, the red pilot light of button **7** will blink 3 times and the message **Err** is displayed to indicate a wrong selection. The machine will not perform the new selected programme.

### Select the spin speed by pressing button **2**

When selecting a programme, the appliance proposes automatically the maximum spin speed provided for that programme. (See

"Washing programmes" for the maximum allowed spin speed).

Press this button repeatedly to change the spin speed, if you want your laundry to be spun at a different speed. The relevant pilot light illuminates.

### Select the available options by means of buttons 3, 4 and 6

Depending on the programme, different options can be combined. These must be selected after choosing the desired programme and before starting the programme. When these buttons are pressed, the corresponding pilot lights illuminate. When they are pressed again, the pilot lights go out. If an incorrect option is selected, the integrated **red** pilot light of the button **7** flashes 3 times and the message **Err** is displayed.

For the compatibility among the washing programmes and the options see chapter «**Washing programmes**».

### Start the programme by pressing button 7

To start the selected programme, press this button; the corresponding green pilot light stops blinking.

The pilot light **9** illuminates to indicate that the appliance starts operating and the door is locked.

If you have chosen a delayed start, the machine will begin the countdown.

**Important!** If an incorrect option is selected, the message **Err** is displayed for a few seconds and the **red** pilot light of this button blinks 3 times.

### Select the Delay Start by pressing button 8

Before you start the programme, if you wish to delay the start, press this button to select the desired delay.

The selected delay time value will appear on the display for a few seconds, then the duration of the programme will appear again.

You must select this option after you have set the programme and before you start the programme.

You can cancel or modify the delay time at any moment, before you press button **7**.

Selecting the delay start :

1. Select the programme and the required options.
2. Select the delay start by pressing button **8**.
3. Press button **7**:
  - the machine starts its hourly countdown.
  - the programme will start after the selected delay has expired.

Cancelling the Delay Start after having started the programme:

1. Set the washing machine to PAUSE by pressing button **7**.
2. Press button **8** once. On the display will appear .
3. Press button **7** again to start the programme.

### Important!

- The selected delay can be changed only after selecting the washing programme again.
- The door will be locked throughout the delay time. If you need to open the door, you must first set the washing machine to PAUSE by pressing button **7** and wait a few minutes before opening the door. After you have closed the door, press the same button again.

**Important!** The Delay Start **cannot** be selected with the draining programme.

### Altering an option or a running programme

It is possible to change some options before the programme carries them out.

Before you make any change, you must pause the washing machine by pressing button **7**.

Changing a running programme is possible only by resetting it. Turn the programme selector dial to  and then to the new programme position. Start the new programme by pressing button **7** again.

The washing water in the tub will be not emptied out.

### Interrupting a programme

Press the button **7** to interrupt a programme which is running, the corresponding pilot light starts blinking. Press the button again to **re-start** the programme.

## Canceling a programme

Turn the selector dial to ① to cancel a programme which is running. Now you can select a new programme.

## Opening the door after the programme has started

First set the machine to pause by pressing the button **7**.

If the pilot light **9** blinks and after a few minutes goes off, the door can be opened.

If the pilot light **9** remains lit, this means that the machine is already heating or that the water level is too high. In any case, do not try to force the door open!

If you cannot open the door but you need to open it, you have to switch the machine off by turning the selector dial to ①. After a few minutes the door can be opened.

**(Pay attention to the water level and temperature!).**

After closing the door, it is necessary to select the programme and options again and to press button **7**.

## At the end of the programme

The machine stops automatically. The blinking  appears on the display, the pilot light of button **7** and the pilot light **9** go off.

## Use - Drying

### Drying only

 The recommended load size is 3 kg for cottons and linen and 2 kg for synthetic items.

By pressing **Drying Time** button it is also possible to dry up to 4 kg of cotton items (see the «Drying Programme » table).

 **Caution!** The water tap must be open and the drain hose must be positioned in the sink or connected to the drain pipe.

1. Load the laundry.
2. Set the spin programme at the maximum spin speed allowed for the type of laundry to remove any residual moisture and obtain the best drying performances.

If a programme or an option that ends with water left in the tub has been selected, the pilot light **9** remains on and the door is locked to indicate that the water must be emptied out before opening the door.

Before you empty out the water, the drum continues to run at regular intervals until the water draining.

Follow the below instructions to empty out the water:

1. Turn the programme selector dial to ①.
2. Select the draining or spinning programme.
3. Reduce the spin speed if needed, by pressing the relevant button.
4. Press button **7**.

At the end of the programme, the door is released and can be opened. Turn the programme selector dial to ① to switch the machine off.

Remove the laundry from the drum and carefully check that the drum is empty. If you do not intend to carry out another wash, close the water tap. Leave the door open to prevent the formation of mildew and unpleasant smells.



3. Set the drying programme for Cottons or Synthetic in the Drying sector of the programme selector dial.
4. Set the drying time by pressing button **5** until the time you want appears on the display (see the «Drying Programme» table). Every time you press this button the drying time increases by 5 minutes.

 The programme time will automatically increase by some minutes.

5. Press button **7** to start the programme. The time remaining is updated every minute.
6. At the end of the programme, the buzzer sounds. The blinking  appears on the display. The door pilot light **9** is on.





During the last minutes of the drying cycle the appliance performs an anti-crease phase. Through this time the door is locked. The display shows the blinking . At the end of the anti-crease phase the door pilot light **9** is off.

 If you wish to open the door before or during the anti-crease phase or to interrupt it, press any button or turn the programme selector dial to any programme position (except ).

7. Turn the selector dial to the  position to switch the machine off.

8. Remove the laundry from the drum.

 The different type of cottons (towelling, sheets, shirts, and so on) or any laundry items rolling up during the spinning phase may result in partial dryness. In the exceptional case that at the end of the cycle the laundry remains slightly wet, we suggest that you unfold the rolled up items, redistribute them evenly in the drum and select an additional drying cycle of 20-30 minutes.

 If you set only 10 minutes of drying phase with the drying time button (5), the appliance performs only a cooling phase.

### **NON-STOP programme - Washing and Timed Drying**

The recommended load size is 3 kg for cotton and 2 kg for synthetic.

 It is also possible to dry up to 4 kg of cotton items (see the «Drying Programme » table).

 **Caution! Do not use a dosing device/ball when carrying out a washing and drying programme.**

1. Load the laundry and add detergent and fabric softener.
2. Switch the machine on by turning the selector dial to the set washing programme/fabric.
3. Select the required options by pressing the relevant buttons.

 **If possible, do not select a spin speed lower than that proposed by the appliance to avoid too long a drying time therefore saving energy.**

In any case the reduction of the spin speed is only possible after selecting drying.

The lowest values you can select are 900 r.p.m. for cottons and synthetics and 700 r.p.m. for delicate fabrics.

4. Set the drying time by pressing button **5**. The display shows the whole duration of the washing and the set drying cycle.

 If you set a washing programme and only 10 minutes of drying cycle, the total duration displayed includes also the unrolling and the cooling phase.

5. Start the programme by pressing button **7**. The time remaining is updated every minute on the display.

6. At the end of the programme turn the selector dial to the  position to switch the machine off and remove the laundry.

### **Fluff in the garments**

During the WASHING AND/OR DRYING PHASE, certain types of fabric, as sponge-cloth, wool, sweatshirt, could release fluff.

The released fluff could stick to the fabrics during the next cycle.

This drawback increases with technical fabrics. To prevent the lint in your clothes, it is recommended:

- To do not wash dark fabrics after you washed and dried light colored fabrics (new sponge, wool, sweatshirt especially) and vice versa.
- To air-dry this type of fabrics when they are washed the first time.
- To clean the filter.
- Perform one or more rinse cycles to wash the drum between the washing and drying of fabrics with different colors.
- After the drying phase, thoroughly clean the empty drum, the gasket and the door with a wet rag.

## Care and cleaning

**Warning!** You must **DISCONNECT** the appliance from the electricity supply, before you can carry out any cleaning or maintenance work.

### Descaling

The water we use normally contains lime. It is a good idea to periodically use a water softening powder in the machine. Do this separately from any laundry washing, and according to the softening powder manufacturer's instructions. This will help to prevent the formation of lime deposits.

### External cleaning

Clean the exterior cabinet of the appliance with soap and water only, and then dry thoroughly.

### Cleaning the dispenser drawer

The washing powder and additive dispenser drawer should be cleaned regularly.

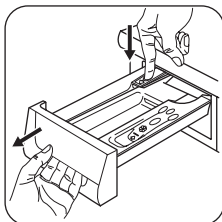

Remove the drawer by pressing the catch downwards and by pulling it out. Flush it out under a tap, to remove any traces of accumulated powder.

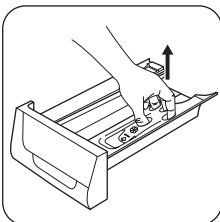

To aid cleaning, the top part of the additive compartment should be removed.

### Cleaning the drawer recess

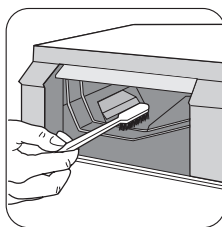

Having removed the drawer, use a small brush to clean the recess, ensuring that all washing powder residue is removed from the upper and lower part of the recess.

Replace the drawer and run the rinse programme without any clothes in the drum.

### Cleaning the pump

The pump should be inspected regularly and particularly if:

- the appliance does not empty and/or spin;
- the appliance makes an unusual noise during draining due to objects such as safety pins, coins etc. blocking the pump;
- a problem with water draining is detected (see chapter "What to do if..." for more details).

**Warning!** Before opening the pump door, switch the appliance off and remove the mains plug from the socket.

Proceed as follows:

- Unplug the appliance.
- If it is necessary, wait until the water has cooled down.

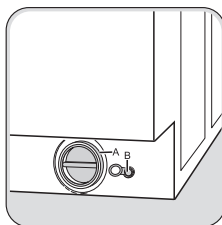

Place a container close to the pump **(A)** to collect any spillage. Pull out the emergency emptying hose **(B)**, place it in the container and remove its cap.

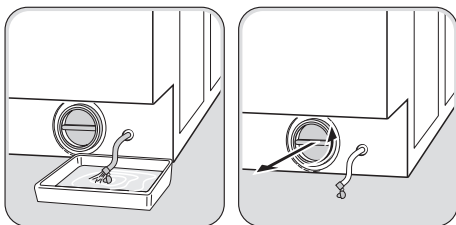

When no more water comes out, unscrew the pump cover by turning it anti-clockwise and remove the filter. Use pliers, if necessary. Always keep a rag nearby to dry up any water spillage when removing the cover. Clean the filter under a tap, to remove any traces of fluff.

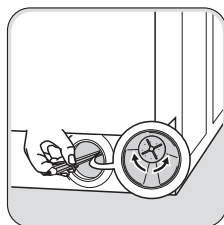

Remove foreign bodies and fluff from the filter seat and from the pump impeller. Check carefully whether the pump impeller rotates (it rotates jerkily). If it doesn't rotate, please contact your Service Centre.

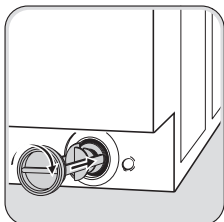

Put the cap back on the emergency emptying hose and place the latter back in its seat.

Replace the filter into the pump by inserting it correctly into the special guides. Screw the pump cover firmly by turning it clockwise.

**Caution!** When the appliance is in use and depending on the programme selected there can be hot water in the pump. Never remove the pump cover during a wash cycle, always wait until the appliance has finished the cycle, and is empty. When refitting the pump cover, ensure it is securely re-

tightened so as to stop leaks and young children being able to remove it.

## Cleaning the water inlet filters

**Important!** If the appliance doesn't fill, takes long to fill with water, the starting button blinks yellow or the display (if available) shows the relevant alarm (see chapter "What to do if..." for more details), check if the water inlet filters are blocked.

To clean the water inlet filters:

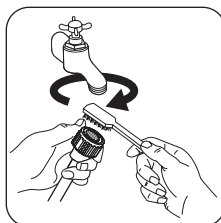

- Turn off the water tap.
- Unscrew the hose from the tap.
- Clean the filter in the hose with a stiff brush.

- Screw the hose back onto the tap. Make sure the connection is tight.

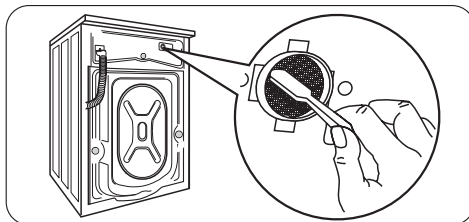

- Unscrew the hose from the machine. Keep a rag nearby because some water may flow.
- Clean the filter in the valve with a stiff brush or with the piece of cloth.

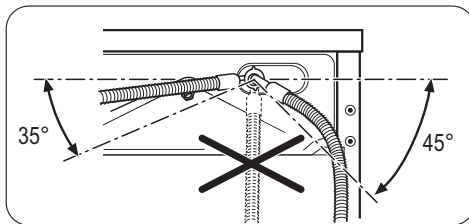

- Screw the hose back to the machine and make sure the connection is tight.
- Turn on the water tap.

### Frost precaution

If the machine is exposed to temperatures below 0°C, certain precautions should be taken.

- Turn off the water tap.
- Unscrew the inlet hose.
- Place the end of the emergency emptying hose and that of the inlet hose in a bowl placed on the floor and let water drain out.
- Screw the water inlet hose back on and reposition the emergency emptying hose after having put the cap on again.
- When you intend to start the machine up again, make sure that the room temperature is above 0°C.

### Emergency emptying out

If the water is not discharged, proceed as follows to empty out the machine:

- pull out the plug from the power socket;
- close the water tap;

## What to do if...

Certain problems are due to lack of simple maintenance or oversights, which can be solved easily without calling out an engineer. Before contacting your local Service Centre, please carry out the checks listed below. During machine operation it is possible that the **red** pilot light of button **7** blinks, one of the following alarm codes appears on the display and some acoustic signals sound every 20 seconds to indicate that the machine is not working:

- if necessary, wait until the water has cooled down;
- open the pump door;
- place a bowl on the floor and place the end of the emergency emptying hose into the bowl. Remove its cap. The water should drain by gravity into the bowl. When the bowl is full, put the cap back on the hose. Empty the bowl. Repeat the procedure until water stops flowing out;
- clean the pump if necessary as previously described;
- replace the emergency emptying hose in its seat after having plugged it;
- screw the pump cover again and close the door.

**Important!** Every time you drain the water through the emergency emptying hose you must pour 2 litres of water into the main wash compartment of the detergent drawer and then run the drain programme. This will activate the **ECO Valve** device avoiding that part of the detergent remains unused at next washing.

- **E10** : problem with the water supply.
- **E20** : problem with the water draining.
- **E40** : door open.

Once the problem has been eliminated, press the button **7** to restart the programme. If after all checks, the problem persists, contact your local Service Centre.

Problem	Possible cause/Solution
<b>The machine does not start:</b>	<p>The door has not been closed. <i>E40</i></p> <ul style="list-style-type: none"> <li>▪ Close the door firmly.</li> </ul> <p>The plug is not properly inserted in the power socket.</p> <ul style="list-style-type: none"> <li>▪ Insert the plug into the power socket.</li> </ul> <p>There is no power at the socket.</p> <ul style="list-style-type: none"> <li>▪ Please check your domestic electrical installation.</li> </ul> <p>The main fuse has blown.</p> <ul style="list-style-type: none"> <li>▪ Replace the fuse.</li> </ul> <p>The selector dial is not correctly positioned and the button <b>7</b> has not been pressed.</p> <ul style="list-style-type: none"> <li>▪ Please turn the selector dial and press the button <b>7</b> again.</li> </ul> <p>The delay start has been selected.</p> <ul style="list-style-type: none"> <li>▪ If the laundry are to be washed immediately, cancel the delay start.</li> </ul> <p>The Child Safety Lock has been activated.</p> <ul style="list-style-type: none"> <li>▪ Deactivate the Child Safety Lock.</li> </ul>
<b>The machine does not fill:</b>	<p>The water tap is closed. <i>E10</i></p> <ul style="list-style-type: none"> <li>▪ Open the water tap.</li> </ul> <p>The inlet hose is squashed or kinked. <i>E10</i></p> <ul style="list-style-type: none"> <li>▪ Check the inlet hose connection.</li> </ul> <p>The filter in the inlet hose or the inlet valve filter are blocked. <i>E10</i></p> <ul style="list-style-type: none"> <li>▪ Clean the water inlet filters. (See "Cleaning the water inlet filters" for more details).</li> </ul> <p>The door is not properly closed. <i>E40</i></p> <ul style="list-style-type: none"> <li>▪ Close the door firmly.</li> </ul>
<b>The machine does not empty and/or does not spin:</b>	<p>The drain hose is squashed or kinked. <i>E20</i></p> <ul style="list-style-type: none"> <li>▪ Check the drain hose connection.</li> </ul> <p>The drain filter is clogged. <i>E20</i></p> <ul style="list-style-type: none"> <li>▪ Clean the drain filter.</li> </ul> <p>An option or a programme that ends with the water still in the tub or a that eliminates all the spinning phases has been selected.</p> <ul style="list-style-type: none"> <li>▪ Select the draining or spinning programme.</li> </ul> <p>The laundry is not evenly distributed in the drum.</p> <ul style="list-style-type: none"> <li>▪ Redistribute the laundry.</li> </ul>

Problem	Possible cause/Solution
<b>There is water on the floor:</b>	<p>Too much detergent or unsuitable detergent (creates too much foam) has been used.</p> <ul style="list-style-type: none"> <li>▪ Reduce the detergent quantity or use another one.</li> </ul> <p>Check whether there are any leaks from one of the inlet hose fittings. It is not always easy to see this as the water runs down the hose; check to see if it is damp.</p> <ul style="list-style-type: none"> <li>▪ Check the water inlet hose connection.</li> </ul> <p>The drain or inlet hose is damaged.</p> <ul style="list-style-type: none"> <li>▪ Replace it with a new one.</li> </ul> <p>The emergency emptying cap has not been replaced into the filter or the filter has not been properly screwed in after cleaning action.</p> <ul style="list-style-type: none"> <li>▪ Refit the emergency emptying cap into the filter or screw the filter fully in.</li> </ul>
<b>Unsatisfactory washing results:</b>	<p>Too little detergent or unsuitable detergent has been used.</p> <ul style="list-style-type: none"> <li>▪ Increase the detergent quantity or use another one.</li> </ul> <p>Stubborn stains have not been treated prior to washing.</p> <ul style="list-style-type: none"> <li>▪ Use commercial products to treat the stubborn stains.</li> </ul> <p>The correct temperature was not selected.</p> <ul style="list-style-type: none"> <li>▪ Check if you have selected the correct temperature.</li> </ul> <p>Excessive laundry load.</p> <ul style="list-style-type: none"> <li>▪ Reduce the laundry load.</li> </ul>
<b>The door will not open:</b>	<p>The programme is still running.</p> <ul style="list-style-type: none"> <li>▪ Wait the end of washing cycle.</li> </ul> <p>The door lock has not been released.</p> <ul style="list-style-type: none"> <li>▪ Wait until the pilot light <b>9</b> goes off.</li> </ul> <p>There is water in the drum.</p> <ul style="list-style-type: none"> <li>▪ Select drain or spin programme to empty out the water.</li> </ul>
<b>The machine vibrates is noisy:</b>	<p>The transit bolts and packing have not been removed.</p> <ul style="list-style-type: none"> <li>▪ Check the correct installation of the appliance.</li> </ul> <p>The support feet have not been adjusted</p> <ul style="list-style-type: none"> <li>▪ Check the correct levelling of the appliance.</li> </ul> <p>The laundry is not evenly distributed in the drum.</p> <ul style="list-style-type: none"> <li>▪ Redistribute the laundry.</li> </ul> <p>Maybe there is very little laundry in the drum.</p> <ul style="list-style-type: none"> <li>▪ Load more laundry.</li> </ul>
<b>Spinning starts late or the machine does not spin:</b>	<p>The electronic unbalance detection device has cut in because the laundry is not evenly distributed in the drum. The laundry is redistributed by reverse rotation of the drum. This may happen several times before the unbalance disappears and normal spinning can resume. If, after 10 minutes, the laundry is still not evenly distributed in the drum, the machine will not spin. In this case, redistribute the load manually and select the spin programme.</p> <ul style="list-style-type: none"> <li>▪ Redistribute the laundry.</li> </ul> <p>The load is too small.</p> <ul style="list-style-type: none"> <li>▪ Add more items, redistribute the load manually and then select the spinning programme.</li> </ul>

Problem	Possible cause/Solution
<b>The machine does not dry or does not dry properly:</b>	<p>The drying time has not been selected.</p> <ul style="list-style-type: none"> <li>▪ Select the drying time.</li> </ul> <p>The water tap is not turned on. <i>E10</i></p> <ul style="list-style-type: none"> <li>▪ Open the water tap.</li> </ul> <p>The drain filter is clogged. <i>E20</i></p> <ul style="list-style-type: none"> <li>▪ Clean the drain filter.</li> </ul> <p>The machine is overloaded.</p> <ul style="list-style-type: none"> <li>▪ Reduce the laundry load.</li> </ul> <p>The selected drying time or the drying programme was not suitable for the laundry.</p> <ul style="list-style-type: none"> <li>▪ Select the suitable drying time/programme for the laundry.</li> </ul>
<b>The laundry is full of different coloured fluff:</b>	<p>The fabrics washed in the previous cycle released fluff of a different colour (refer to "Fluff in the garments" in chapter 'Use - Washing &amp; Drying').</p> <ul style="list-style-type: none"> <li>▪ The drying phase helps to eliminate some fluff.</li> <li>▪ Clean the clothes with a fluff remover.</li> </ul> <p>In case of an excessive amount of fluff in the drum repeat the following procedure twice:</p> <ul style="list-style-type: none"> <li>▪ Thoroughly clean the empty drum, the gasket and the door with a wet rag.</li> <li>▪ Perform a rinse cycle.</li> <li>▪ Put a wool or piled fabric rag inside the drum.</li> <li>▪ Perform a drying cycle of 10 minutes.</li> <li>▪ Remove the old wool cloth.</li> </ul> <p>Now you can wash other garments.</p>
<b>The machine makes an unusual noise:</b>	<p>The machine is fitted with a type of motor which makes an unusual noise compared with other traditional motors. This new motor ensures a softer start and more even distribution of the laundry in the drum when spinning, as well as increased stability of the machine.</p>
<b>No water is visible in the drum:</b>	<p>Machines based on modern technology operate very economically using very little water without affecting performance.</p>

If you are unable to identify or solve the problem, contact our service centre. Before telephoning, make a note of the model, serial number and purchase date of your machine: the Service Centre will require this information.

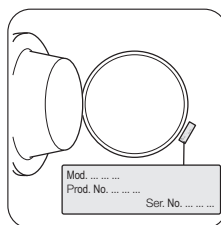

## Technical data

Dimensions	Width	60 cm
	Height	85 cm
	Depth	55 cm

Electrical connection Voltage - Overall power - Fuse	Information on the electrical connection is given on the rating plate, on the inner edge of the appliance door.	
Water Supply Pressure	Minimum Maximum	0,05 MPa 0,8 MPa
Maximum Load	Cotton	7 kg
Maximum Dry Load	Cotton Cotton Big Capacity Synthetic	3 Kg 4 Kg 2 Kg
Spin Speed	Maximum	1200 rpm

## Consumption values

Programme	Energy consumption (kWh)	Water consumption (litres)	Programme duration (Minutes)
Cottons 60°	1.35	67	<b>For the duration of the programmes, please refer to the display on the control panel.</b>
Cotton Energy Saving Programme 60° 1)	1.05	49	
Cottons 40°	0.85	67	
Synthetics 40°	0.55	42	
Delicates 40°	0.55	63	
Wool/ Handwash 30°	0.25	55	

1) «Cotton Energy Saving programme » at 60°C with a load of 7 kg is the reference programme for the data entered in the energy label, in compliance with EEC 92/75 standards.

 The consumption data shown on this chart is to be considered purely indicative, as it may vary depending on the quantity and type of laundry, on the inlet water temperature and on the ambient temperature.

## Installation

### Unpacking

All transit bolts and packing must be removed before using the appliance.

You are advised to keep all transit devices so that they can be refitted if the machine ever has to be transported again.



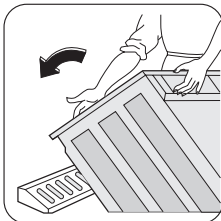

After removing all the packaging, carefully lay machine on it's back to remove the polystyrene base from the bottom.

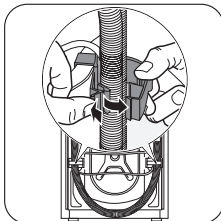

Remove the power supply cable and the hose from the hose holders on the rear of the appliance.

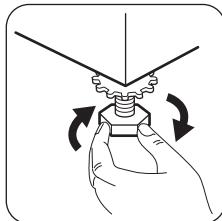

Level the washing machine by raising or lowering the feet. The feet may be tight to adjust as they incorporate a self locking nut, but the machine **MUST** be level and stable. If necessary, check the setting with a spirit level.

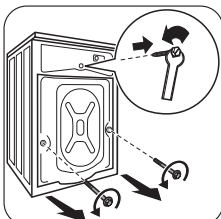

Unscrew the three bolts with the supplied spanner.

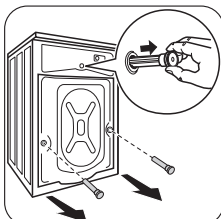

Slide out the relevant plastic spacers.

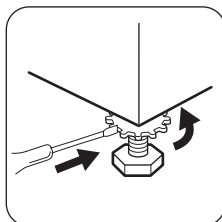

Any necessary adjustment can be made with a spanner.

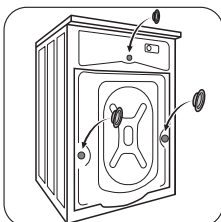

Fill the smaller upper hole and the two large ones with the corresponding plastic plug caps supplied in the bag containing the instruction booklet.

### Positioning

Install the machine on a flat hard floor. Make sure that air circulation around the machine is not impeded by carpets, rugs etc. Check that the machine does not touch the wall or other kitchen units.

Accurate levelling prevents vibration, noise and displacement of the machine during operation.

**! Caution!** Never place cardboard, wood or similar materials under the machine to compensate for any unevenness in the floor. After having levelled the appliance, tighten the lock nuts.

### Raising the appliance

Suspended wooden floors are particularly susceptible to vibration.

To help prevent vibration we recommend you place a waterproof wood panel, at least 15 mm thick under the appliance, secured to at least 2 floor beams with screws, the wood panel must extend beyond the front feet.

If possible install the appliance in one of the corners of the room, where the floor is more stable.

### Water inlet



**Caution!**

- **This appliance must be connected to a cold water supply.**
- Before connecting up the appliance to new pipework or to pipework that has not been used for some time, run off a reasonable amount of water to flush out any debris that may have collected.
- Do not use the hose from your previous appliance to connect to water supply.

The inlet hose is supplied with the appliance and can be found inside the machine drum.

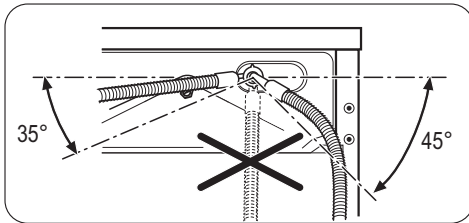

Open the porthole and extract the inlet hose. Connect the appropriate end of the hose to the appliance with the angled connection as showed in the picture. **Do not place the inlet hose downwards.** Angle the hose to the left or right depending on the position of your water tap.

After positioning the inlet hose, be sure to tighten the ring nut again to prevent leaks .

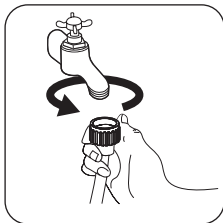

Connect the other end of the inlet hose to a tap with a 3/4" thread. Always use the hose supplied with the appliance.



**Caution!** The inlet hose must not be lengthened. If it is too short and you do not wish to move the tap, you will have to purchase a new, longer hose specially designed for this type of use.



**Warning! Installation should comply with local water authority and building regulations' requirements. The appliance must be connected to a cold water supply.**

A minimum water pressure of 0.05 MPa (0.5 bar) is required for safe operation of the appliance.

If you cannot make the cold water connection direct from the rising mains, you may be able to operate the appliance from your cold water storage system.

There should be a minimum vertical distance of 5.02 m (16.5 ft) between the appliance's inlet and the bottom of the water storage tank.

**Water drainage**

This appliance is designed to be permanently plumbed into your home's drainage system using one of the following methods.

**1. Into a drainage standpipe.**

Firstly form a hook in the end of the drain hose using the "U" piece supplied.

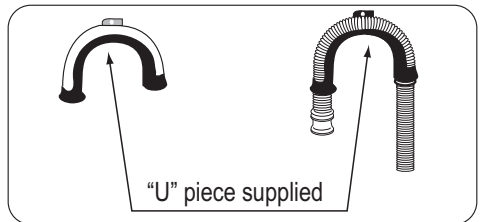

Place the drain hose into your standpipe, which should have an internal diameter of approximately 38 mm thus ensuring there is an air break between the drain hose and standpipe.

When discharging into a standpipe ensure that the top of the standpipe is no more than 90 cm (35.4") and no less than 60 cm (23.6") above floor level.

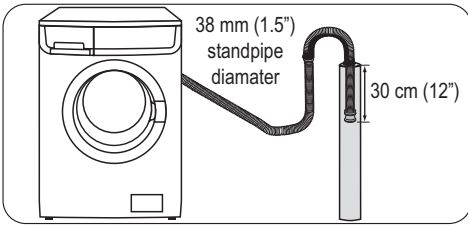

The drain hose may be extended to a maximum of 4 metres. An additional drain hose and joining piece is available from your local Service Force Centre. The joining piece must have an internal diameter of 18 mm.

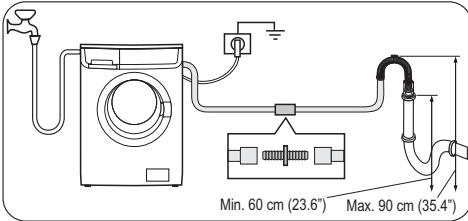

If your drain hose looks like this (see beside) you do not require the “U” piece”. Just push the hose firmly in to the standpipe.

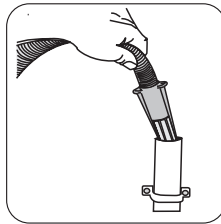

## 2. Onto a sink outlet spigot.

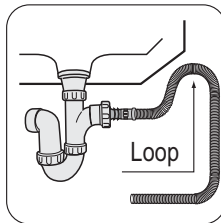
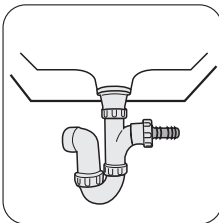

If the outlet spigot has not been used before, remove any blanking plug that may be in place.

Push the drain hose onto the spigot and secure with a clip, ensure a loop is formed in the drain hose (see above) to prevent waste from the sink entering the appliance.

If you intend to drain the hose from the machine into a sink, make sure that the sink is empty and the plug hole is not blocked. Use the plastic “U - Piece” supplied.

## In the interest of the environment

The appliance should be connected to the FOUL drainage system, the water will then be taken to a sewage works for treatment before being discharged safely into a river.

It is essential that these appliances are not connected to the surface water drainage system as this water is discharged directly into a river or stream and may cause pollution.

If you require any further advice please contact your local water authority.

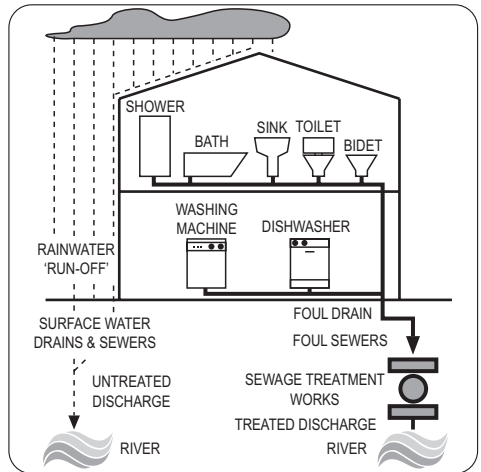

## Building in

This appliance has been designed to be built into the kitchen furniture. The recess should have the dimensions shown in picture A.

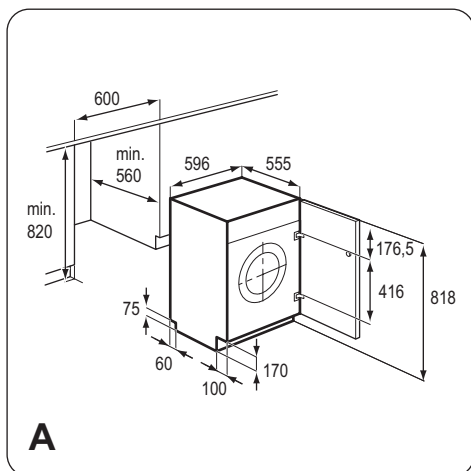

**A**

When installing the appliance into the kitchen furniture ensure, if possible, the hoses are placed in either of the two recesses on the back of the appliance.

This will help to prevent the hoses from becoming kinked or trapped.

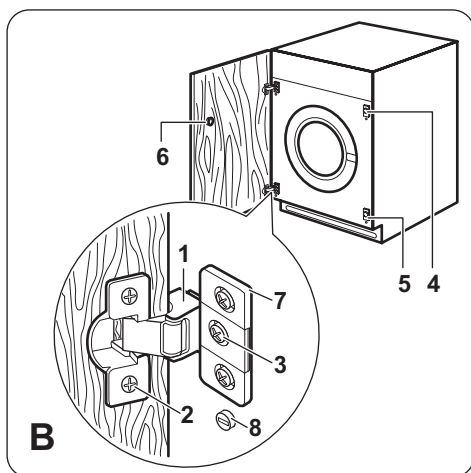

**B**

**! Caution!** Do not remove the screw **8**!

### Preparation and assembly of the door

The machine is originally prearranged for the assembly of a door opening from right to left. In this case it is sufficient to screw in the hinges (**1**) and the counter-magnet (**6**) provided with the appliance, at the right level (Fig. **B**).

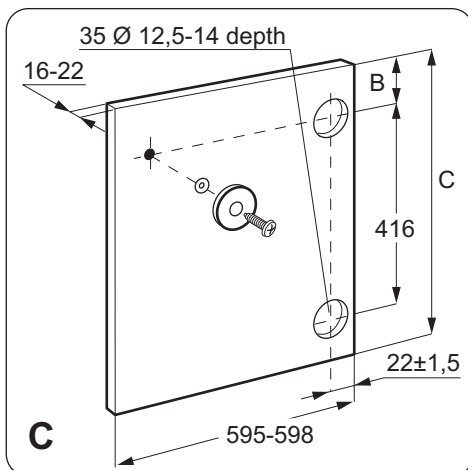

**C**

### ▪ a) Door

The dimensions of the door should be:

- width 595-598 mm
- thickness 16-22 mm

The height (C-Fig. C) depends on the height of the adjacent furniture's base.

### ▪ b) Hinges

To mount the hinges it is necessary to drill two holes (dia. 35 mm, depth 12.5-14 mm depending on the depth of door furniture) on the inner side of the door. The distance between the holes hobs fixing centres must be 416 mm.

The distance (B) from upper edge of the door to the centre of the hole depends on the adjacent furniture's dimensions.

The required dimensions are given in the picture C.

The hinges will be fixed to the door by means of screws for wood (2-Fig. B) supplied with the appliance.

### ▪ c) Mounting the door

Fix the hinges (1) to the machine by means of the M 5x15 screws (3-Fig. B). The hinges can be adjusted to compensate for possible uneven thickness of the door.

To align the door perfectly it is necessary to loosen the screw (3-Fig. B), adjust the door and tighten the screw again.

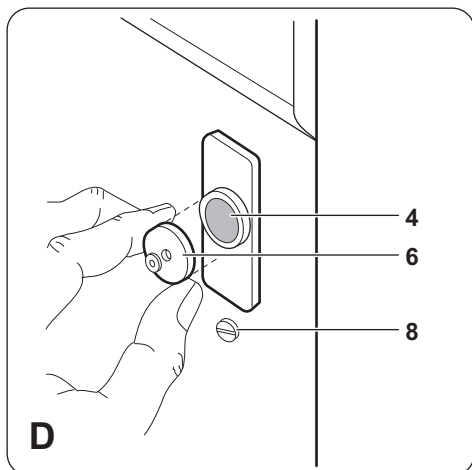

**!** **Caution!** Do not remove the screw **8!**

### d) Counter-magnet (6)

The appliance is prearranged for a magnetic closure of the door.

To enable a correct operation of this device, it is necessary to screw the counter-magnet (6) (steel disk + rubber ring) into the inner side of the door. Its position must correspond to the magnet (4) on the appliance (see picture D).

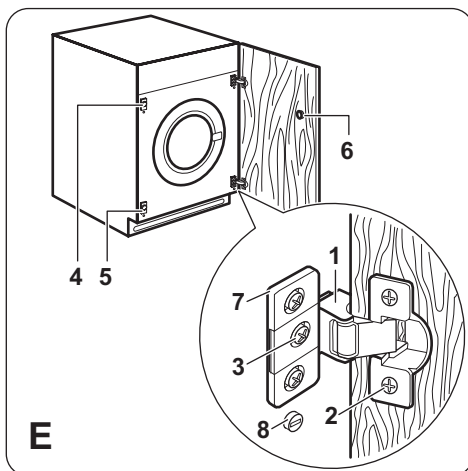

**!** **Caution!** Do not remove the screw **8!**

If the door has to be opened from left to right, invert the position of the plates (7), the magnet (4) and the plate (5) (Fig. B and E).

Mount the counter-magnet (6) and the hinges (1) as previously described.

**Recommendations regarding the construction and fitting of a base when the installation requires an integrated appliance to be raised.**

Graphic F

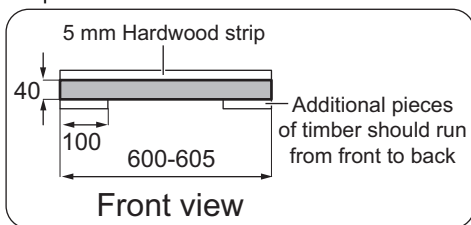

Where the appliance has been raised by mounting onto a wooden base provided by the installer. The material used to construct the base should have an non slip surface, be water repellent and if possible be one solid piece.

If it is not possible to use one solid piece, due to the additional height required, ensure that any additional strips of timber are glued and screwed to the underside of the base (see Fig. F).

Graphic G

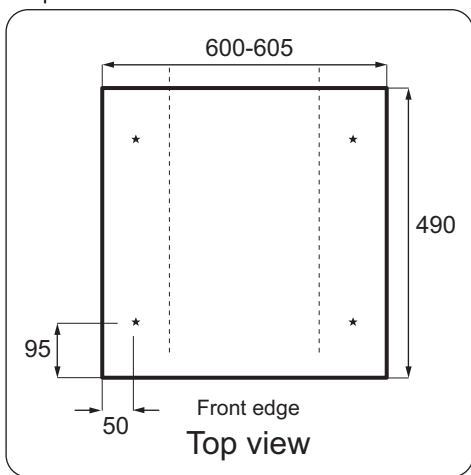

Drill four fixing holes see Fig. G

Position the base into the recess with its front edge as far forward as the adjoining plinth line will allow.

**The reason for placing the base in this position is to allow a small strip of beading to be fitted in front of the appliance feet.**

Graphic H

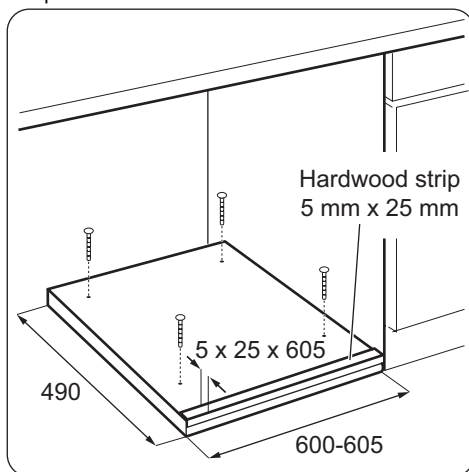

Fix the base firmly to the floor using four appropriate countersunk screws (see Fig. H). With the appliance installed adjust all four feet ensuring the machine is stable, and a clearance of approximately 5 mm is left between the top of the machine and the underside of the worktop.

A final check for stability should be carried out with the machine on spin with a load, this will identify the need for any further fine adjustment to the feet.

A strip of beading approximately 605 mm W, x 5 mm H, x 25 mm D must be screwed down into the base directly in front of the machine's feet, this will provide additional security.

If required an additional door magnet, part number 1242394-00/3 and disc, part number 1242393-00/5 are available from spare parts.

## Electrical connection

---

Information on the electrical connection is given on the rating plate on the inner edge of the appliance door.

Check that your domestic electrical installation can take the maximum load required, also taking into account any other appliances in use.

 **Caution! Connect the machine to an earthed socket.**

 **Warning!** The appliance is supplied with a 13amp plug fitted. In the event of having to change the fuse in the plug supplied, a 13amp ASTA approved (BS1363/A) fuse must be used.

## Environment concerns

---

The symbol  on the product or on its packaging indicates that this product may not be treated as household waste. Instead it should be taken to the appropriate collection point for the recycling of electrical and electronic equipment. By ensuring this product is disposed of correctly, you will help prevent potential negative consequences for the environment and human health, which could otherwise be caused by inappropriate waste handling of this product. For more detailed information about recycling of this product, please contact your local council, your household waste disposal service or the shop where you purchased the product.

### Packaging materials

The materials marked with the symbol  are recyclable.

>PE<=polyethylene

>PS<=polystyrene

 **Caution! The manufacturer does not accept any responsibility for damage or injury through failure to comply with the above safety precaution.**

 **Caution! Should the appliance power supply cable need to be replaced, this MUST be carried out by a Service Centre.**

 **The power supply cable must be easily accessible after installing the machine.**

>PP<=polypropylene

This means that they can be recycled by disposing of them properly in appropriate collection containers.

### Ecological hints

To save water, energy and to help protect the environment, we recommend that you follow these tips:

- Normally soiled laundry may be washed without prewashing in order to save detergent, water and time (the environment is protected too!).
- The machine works more economically if it is fully loaded.
- With adequate pre-treatment, stains and limited soiling can be removed; the laundry can then be washed at a lower temperature.
- Measure out detergent according to the water hardness, the degree of soiling and the quantity of laundry being washed.



[www.zanussi.com/shop](http://www.zanussi.com/shop)



132927931-A-462012